

9097250 TOSHIBA (DISCRETE/OPTO)

56C 07606 D T-33-07

SILICON NPN EPITAXIAL TYPE (PCT PROCESS)

**2SC2824**

AUDIO FREQUENCY POWER AMPLIFIER APPLICATIONS.

## FEATURES:

- Complementary to 2SA1184.
- Suitable for driver of 60 to 80 watts audio amplifier.
- High breakdown voltage.

## MAXIMUM RATINGS (Ta=25°C)

CHARACTERISTIC	SYMBOL	RATING	UNIT
Collector-Base Voltage	VCBO	120	V
Collector-Emitter Voltage	VCEO	120	V
Emitter-Base Voltage	VEBO	5	V
Collector Current	IC	1	A
Base Current	IB	100	mA
Collector Power Dissipation	PC	Ta=25°C	1
		Tc=25°C	15
Junction Temperature	Tj	150	°C
Storage Temperature Range	Tstg	-55~150	°C

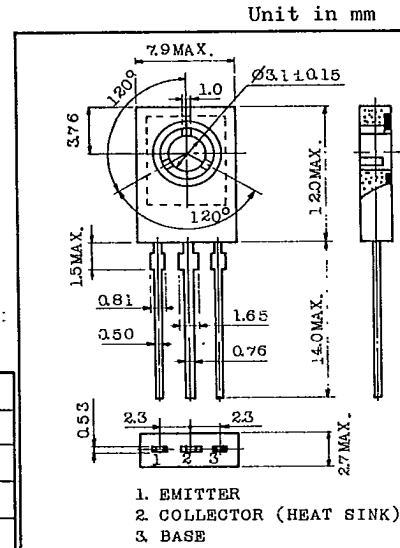

JEDEC	TO-126
EIAJ	-
TOSHIBA	2-8F1A

Mounting Kit No. AC46C  
Weight : 0.72g

## ELECTRICAL CHARACTERISTICS (Ta=25°C)

CHARACTERISTIC	SYMBOL	TEST CONDITION	MIN.	TYP.	MAX.	UNIT
Collector Cut-off Current	ICBO	V <sub>CB</sub> =120V, I <sub>E</sub> =0	-	-	100	nA
Emitter Cut-off Current	IEBO	V <sub>EB</sub> =5V, I <sub>C</sub> =0	-	-	100	nA
Collector-Emitter Breakdown Voltage	V(BR)CEO	I <sub>C</sub> =10mA, I <sub>B</sub> =0	120	-	-	V
Emitter-Base Breakdown Voltage	V(BR)EBO	I <sub>E</sub> =1mA, I <sub>C</sub> =0	5	-	-	V
DC Current Gain	h <sub>FE</sub> (Note)	V <sub>CE</sub> =5V, I <sub>C</sub> =100mA	80	-	240	
Collector-Emitter Saturation Voltage	V <sub>CE(sat)</sub>	I <sub>C</sub> =500mA, I <sub>B</sub> =50mA	-	0.30	1.0	V
Base-Emitter Voltage	V <sub>BE</sub>	V <sub>CE</sub> =5V, I <sub>C</sub> =500mA	-	0.78	1.0	V
Transition Frequency	f <sub>T</sub>	V <sub>CE</sub> =5V, I <sub>C</sub> =100mA	-	120	-	MHz
Collector Output Capacitance	C <sub>ob</sub>	V <sub>CB</sub> =10V, I <sub>E</sub> =0, f=1MHz	-	15	-	pF

Note: h<sub>FE</sub> Classification    0:80~160    Y:120~240

TOSHIBA CORPORATION

**2SC2824**

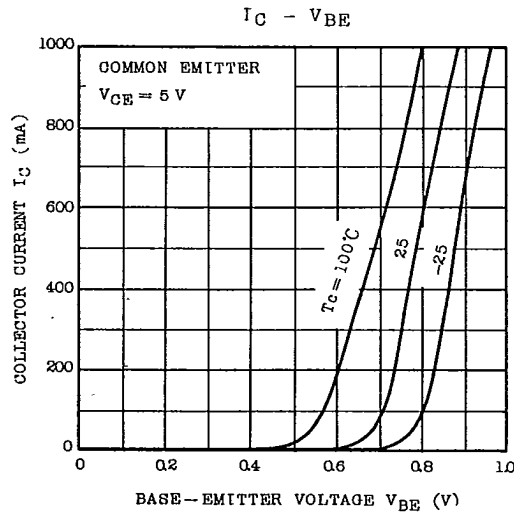
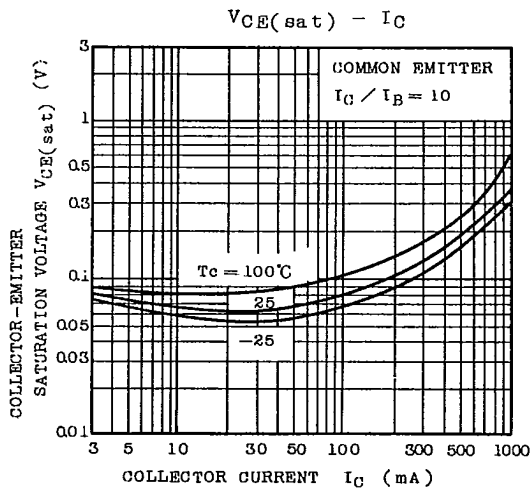
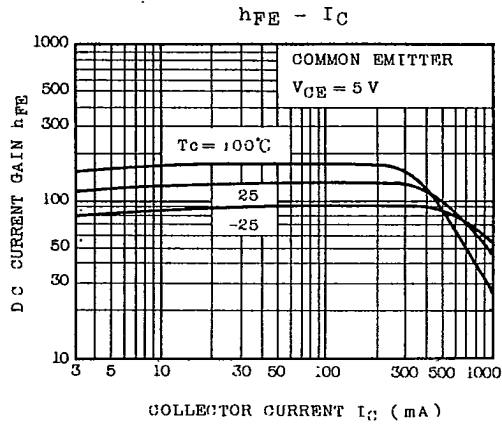
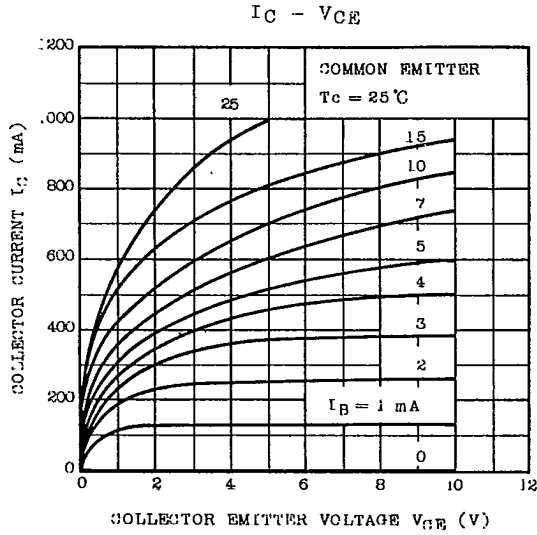

TOSHIBA CORPORATION

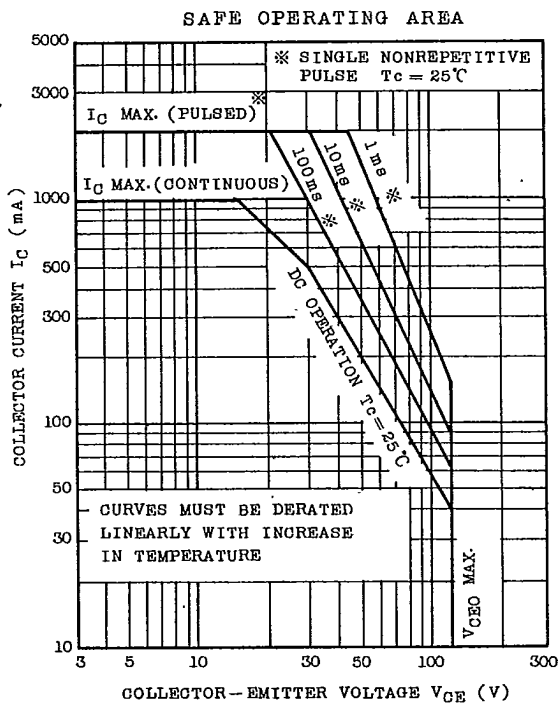
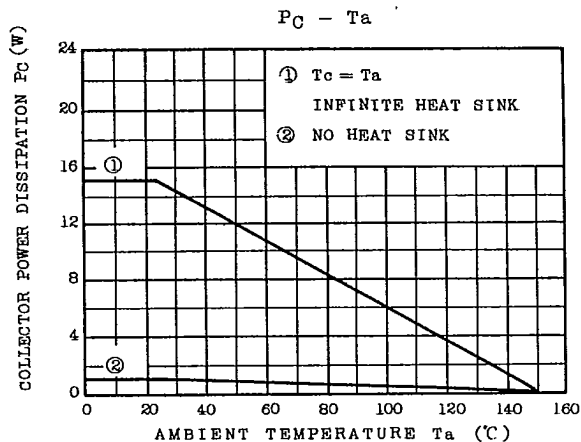

TOSHIBA CORPORATION

This datasheet has been downloaded from:

[www.DatasheetCatalog.com](http://www.DatasheetCatalog.com)

Datasheets for electronic components.